

Overview and Experiences of Biomass Fluidized Bed Gasification in Thailand

S. Pipatmanomai^{1,2,*}

¹The Joint Graduate School of Energy and Environment, King Mongkut's University of Technology Thonburi, Bangkok, Thailand

²Center for Energy Technology and Environment, Ministry of Education, Thailand

*Corresponding Author: suneerat@jgsee.kmutt.ac.th

Abstract: This paper presents an overview and experiences of implementation and research studies of biomass gasification in Thailand. An overview of biomass utilisation and status of biomass conversion technologies especially power generation via gasification route is described. Then, the research experiences in biomass fluidized bed gasification studies at JGSEE are reviewed and discussed, which include the investigation of synthesis gas potential in terms of both technical and economic aspects, co-gasification of high-moisture biomass with other fuel wastes, and the investigation of tar formation in bubbling fluidized bed gasifier. The future research activities will focus on the development of an efficient and affordable tar reduction process.

Keywords: Biomass; Gasification; Fluidized Bed; Power Generation; Tar.

1. Overview and status of biomass gasification in Thailand

As an agricultural country, Thailand produces considerable amount of biomass each year. Most of biomass has been utilized for energy purpose, mainly by direct combustion (which converts solid biomass into heat). However, gasification, which converts solid biomass into fuel gas containing CO and H₂ or so-called synthesis gas, has been considered as a promising alternative owing to a number of advantages. Flexible applications of the synthesis gas can be realized including the oil boilers, gas boilers, or cement kilns, etc., with no or minor modification of the burner. When utilizing the gasification-derived hot synthesis gas as fuel for heat, it can be readily used without prior extensive treatment and its sensible heat can also be beneficial. Apart from gasification for heat production, biomass gasification for electricity or combined heat and electricity production especially at small scales has drawn great attention as a more efficient and economical option compared to via conventional combustion steam cycle [1].

There are a number of gasification system installations for power generation in Thailand, most of which were imported. Some applied for the governmental promoted VSPP (Very Small Power Producer) scheme but some simply produce power for their own consumption. The latter often are the owner of biomass fuels, e.g. rice mill owners. The fluidized bed type, all imported from China, has a capacity ranging from a few hundreds kWe to 1 MWe; while the fixed bed downdraft type imported from India and Japan covers only a small capacity range of a few hundreds kWe.

Although successful industrial applications of biomass gasification for heat production have been realized in Thailand despite a limited references, continuous operation of gasification systems for power generation to ensure technical stability and long term economic feasibility have not been fully achieved so far. One of the main barriers is the removal of tar present in the product gas. Above the acceptable limit of tar content in the synthesis gas entering the internal combustion engine, tar condensation can clog and damage engine parts. Therefore, a better understanding of the biomass gasification and tar formation is highly necessary for the improvement of the gasification process and the development of an efficient and affordable tar reduction process.

2. Biomass fluidized bed gasification studies: Experiences at JGSEE

The study of coal and biomass thermal conversion in fluidized bed reactors is among the most active research studies at JGSEE. The research team led by the author has been carrying out intensive combustion and gasification during the past several years. The in-house bubbling fluidized bed (BFB) and circulating

fluidized bed (CFB) facilities were developed and are located at the JGSEE's pilot plant at the KMUTT's Bangkhuntien Campus. While the preliminary study in CFB facility has focused on combustion of lignite and low grade coals; BFB facility has been dedicated to biomass gasification studies. The main biomass feedstock used is rubber woodchip, which is generated from wood processing manufactures and originated mainly in the south of Thailand where rubber trees are planted for latex production. The rubber woodchip is one of the highest potential biomass resources in Thailand [2].

2.1 The 100 kWth bubbling fluidized bed gasification system

The bubbling fluidized bed gasifier used as the main facility for biomass gasification studies has a rated thermal capacity of about 100 kW and operates with air as a gasifying agent at atmospheric pressure. Its detailed description and operating procedure has been published previously [3-4]. The schematic diagram of the gasifier is shown in Figure 1. The reactor was lined with refractory having an internal diameter of 300 mm and 2500 mm in height from the air distributor level. The air distributor was designed to be of nozzle-type to promote the re-circulation of gas and solid in the bed zone as well as to prevent the bed aggregation. The biomass feeding system locates at 500 mm above the air distributor. Silica sand having an average particle size of 352 μm was used as the inert bed material.

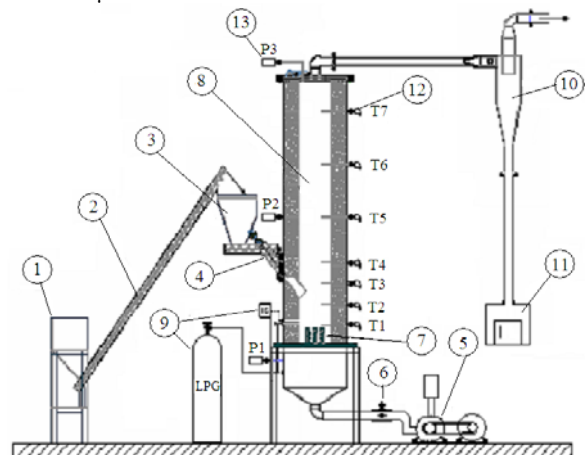

Figure 1. Bubbling fluidized bed gasification system: (1) Ground hopper; (2) Screw conveyor; (3) Upper hopper; (4) Injection screw; (5) Force draft fan; (6) Air flow meter; (7) Air distributor plate; (8) Fluidized bed reactor; (9) Preheating system; (10) Dust cyclone; (11) Ash container; (12) Thermocouples (T1-T7); (13) Pressure transducers (P1-P3).

Seven K-type thermocouple probes were installed to continuously monitor the temperature variation along the height of gasifier. Three were located below and within the bed zone, and four along the freeboard. Three pressure transducers were installed immediately below the air distributor, 1250 mm above the air distributor and at the top of the gasifier. Besides the purpose of determining the minimum fluidization velocity, pressure inside the gasifier was also monitored to keep at slightly negative level to avoid any gas leakages. The positions of thermocouples and pressure transducers are also indicated in Figure 1.

2.2 Potential production of synthesis gas: Technical and Economic analysis

Kaewluan and Pipatmanomai [3] investigated the potential of synthesis gas production from rubber wood chip gasification and its subsequent utilization. The parametric study was carried out to investigate the effect of air to fuel ratio or represented as equivalence ratio (ER) on the synthesis gas yield and properties as well as the gasification efficiency. The mass and energy distribution in the gasification process was conducted to determine the work availability for heat and electricity production as well as the possible energy loss recovery. The economic aspect of using the synthesis gas to replace fossil fuels for heat and electricity production cases was also considered.

The analysis of rubber wood chip is given in Table 1. Experimental results have clearly exhibited a strong influence of ER on gasification temperature and its products. As shown in Figure 2, increasing ER from 0.32 to 0.43, the bed temperature increased from about 750°C by about 100°C. This higher temperature is thought to promote the degree of carbon conversion, hence lower fly ash yield and higher carbon conversion efficiency at higher ER. The optimal operation was achieved at ER = 0.38, with which the obtained gas heating value and gas yield were found to be 4.94 MJ/Nm³ of dry synthesis gas, 2.33 Nm³ dry synthesis gas / kg of dry biomass, respectively. The resulting gasification efficiencies at various ER are presented in Figure 3. At the optimum ER, the hot efficiency (i.e. hot gas would be directly used) was 80.2%; while the cold efficiency was reduced to 64.1% (i.e. synthesis gas would be used at room temperature, e.g. for engine application) due to a significant loss of sensible heat. Fly ash and tar had very high heating values (i.e. ~13 MJ/kg and ~39 MJ/kg, respectively) and therefore are considered sufficient for energy recovery; however, implementation needs to be further investigated for its economical viability.

Table 1. Analyses of rubber wood chip.

Moisture content (% wt., wet basis)	8.5
Higher heating value (kJ/kg, dry basis)	17057
Proximate analysis (% wt., dry basis)	
Volatile matter	88.9
Fixed carbon	10.0
Ash	1.1
Ultimate analysis (% wt, dry-ash-free basis)	
C	46.4
H	5.7
N	0.2
S	0.0
O	47.7

As a result of the mass and energy balance, the energy distribution in the gasification process is presented in Figure 4. Around 65% of the chemical energy in biomass was converted into the chemical energy in dry gas. The majority of energy loss from the process was the energy lost through moisture containing in the gas stream and the unaccounted losses mainly to surrounding by radiation – together accounting for about 25% of the total output energy. The sensible energy of around 10% could be lost if the product gas is not utilized at the gasifier exit temperature.

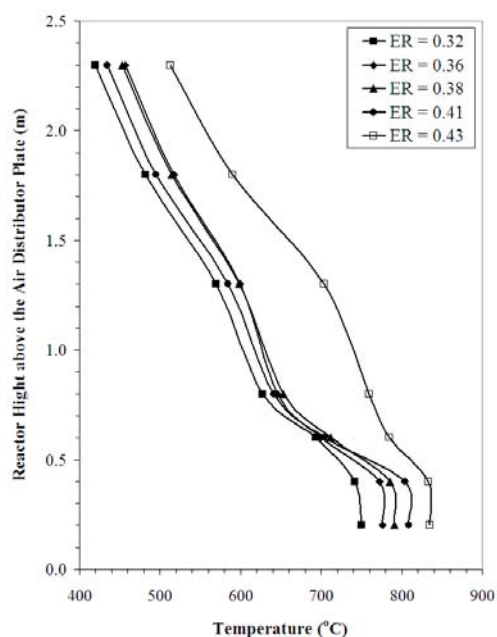

Figure 2. Effect of ER on temperature distribution along the height of gasifier.

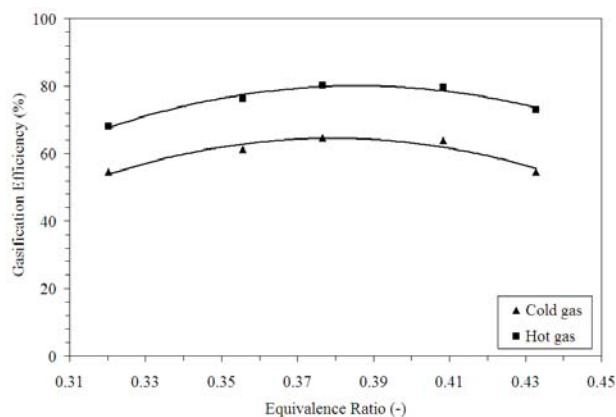

Figure 3. Effect of ER on gasification efficiencies [Cold gas: 300 K; Hot gas: 700 K].

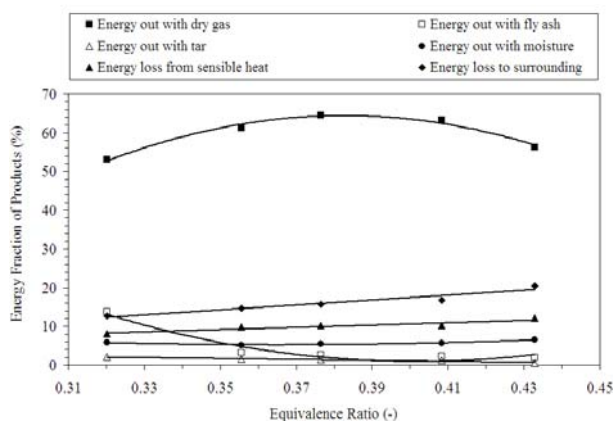

Figure 4. Effect of ER on energy distribution of the gasification process.

Considering the economic aspect of the synthesis gas utilization to replace fossil fuels for heat applications, the annual saving of fuel cost was estimated to be about 70% and 50% in the case of heavy fuel oil and natural gas, respectively, which is economically attractive. However, the case of electricity production does not seem a preferable option and that is due to its current

technical and non-technical barriers including the low overall efficiency, the high operation and maintenance cost due to excessive tar contamination and the low electricity price in Thailand, which makes energy from biomass less competitive to fossil energy.

2.3 Co-gasification of high-moisture biomass with other fuel wastes

Rubber woodchip is one of the typical high-moisture biomass. The freshly-cut woodchip has the moisture content in the range of 30 to 50%, which is too high even for fluidized bed gasifiers [5-6]. The increase in the moisture content was found to consistently reduce both bed and freeboard temperature. This temperature drop consequently yielded a negative effect on the equilibrium of further gasification reactions, and hence the quality of synthesis gas [7]. Therefore, pre-treatment (typically pre-drying) to reduce the moisture content in biomass is necessary to meet the acceptable level for gasification operation. Alternatively, the high moisture woodchip may be mixed with other materials of equal or better quality and of lower moisture content.

Kaewluan and Pipatmanomai [7] investigated the gasification of mixtures between high moisture rubber woodchip with 27% moisture content (RW) and rubber waste (SR). The analyses for elemental composition, ash and moisture content and heating value of the individual materials and mixtures are shown in Table 2. Only the experimental results at ER = 0.38, the condition at which a good compromise of product gas quality and carbon conversion efficiency was achieved, were reported here. Table 3 presents the experimental results in the case of mixture with 20% SR addition in rubber woodchip (Mixed-20) in comparison with the case of pre-dried rubber woodchip to have 18.1% and 9.5% moisture content. Using Mixed-20, the bed temperature was found to increase by about 70°C from around 700°C observed for the case of 27% moisture content with no SR addition. This is more effective even when compared to the case of pre-dried biomass (i.e. 9.5% moisture content). The increased average bed temperature by the increase of SR addition is thought to be the most important factor promoting the forward Boudouard reaction, due to which CO increased while CO₂ decreased. Due to the resulting higher gasification temperature obtained from gasification with SR addition, it is possible to operate gasification at lower ER compared to the case without SR addition leading to the higher CO/CO₂ production ratio.

The performance and products in the case of co-gasification were significantly improved compared to the case of gasification using the high moisture woodchip alone and almost t for the tar contamination in the synthesis gas. This implies the direct usability of high moisture rubber woodchip by adding shredded rubber waste without the need of pre-drying and moreover an improvement of the gasification performance and products.

Similar approach has also been applied to co-gasification of high-moisture rubber woodchip with plastic waste as reported in the study by Chobthiangtham and Pipatmanomai [8]. The added plastic waste was also found to increase the production of CO and H₂ and hence the increased heating value of the produced synthesis gas.

Table 2. Analyses of the high moisture rubber woodchip (RW) and shredded rubber waste (SR) mixtures at various ratios.

Sample	Mixed-0 (100% RW)	Mixed-10	Mixed-20	Mixed-100 (100% SR)
Composition (% wt, wet basis)				
C	33.5	37.9	42.4	78.1
H	4.2	4.6	5.0	8.4
O	34.4	31.4	28.3	3.7
N	0.1	0.1	0.2	0.3
S	0.0	0.4	0.7	3.7
Ash	0.8	1.2	1.6	4.8
Moisture	27.0	24.4	21.8	1.0
Higher heating value (MJ/kg)	13.0	15.4	17.8	37.1

Table 3. Comparison of the gasification performance and products from co-gasification of rubber wood chip with 20% SR addition (Mixed-20) with gasification of low and medium moisture rubber wood chip at ER = 0.38.

Experimental results	Mixed-20	Medium moisture rubber woodchip	Low moisture rubber woodchip
Moisture content (%)	22.2	18.1	9.5
Average bed temperature (°C)	773	730	761
Average freeboard temperature (°C)	607	621	624
HHV of synthesis gas (MJ/Nm ³)	4.49	4.34	4.71
Gas yield (Nm ³ /kg of dry biomass)	2.65	2.02	2.08
Tar yield (g/Nm ³ of dry gas)	8.5	9.1	4.1
Carbon conversion efficiency (%)	88.4	83.2	86.4
Coal gasification efficiency (%)	66.8	49.1	55.0

2.4 Preliminary investigation of tar formation

Although biomass gasification for power generation has been developed and studied for decades, a wide implementation still cannot be realized. One of the main barriers is the removal of tar present in the product gas. Above the acceptable limit of tar content in the synthesis gas entering the internal combustion engine, tar condensation can clog and damage engine parts.

Many researchers have conducted studies of tar removal by, e.g. catalytic bed materials [9-13], catalytic reforming [14-18], thermal cracking [19-20], etc. However, the tar problems are still a major challenge in the research field of biomass gasification considering both technical and economical aspects. Therefore, a better understanding of the tar formation mechanism would be helpful for investigating the solution of tar reduction in gasification processes.

Here, the formation of tar in a bubbling fluidized bed gasifier using rubber woodchip as fuel was intensively investigated. The tar collection unit used in this study for the gravimetric tar measurement and further composition analysis was modified from the original system developed by Neeft et al. [21] and is schematically shown in Figure 5. A stream of product gas was drawn from the gasifier at a controlled volumetric flow rate and passed through a series of 6 impinger bottles. Each bottle was filled with approximately 125 ml of iso-propanol, the solvent considered the most suitable to capture fluidized-bed generated tars [21]. The first three impinger bottles were placed in a salted ice bath to keep the temperature around 5°C, while the other three were placed in a dry ice bath to lower the temperature to around -20°C to ensure that the tar and moisture would be completely removed from the gas stream. The product gas after tar removal was subject to composition analysis by a combination of online infrared analyzer and micro gas chromatography.

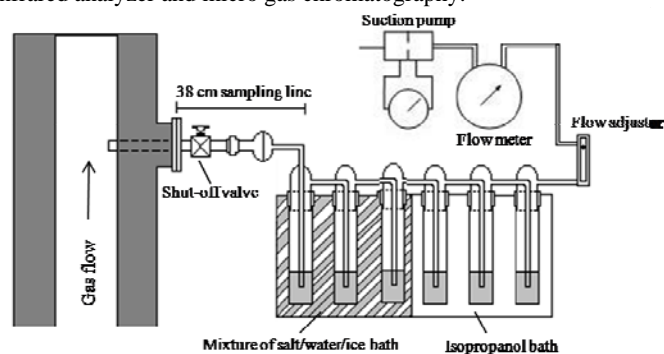

Figure 5. Schematic diagram of the tar collection unit.

The experiment was conducted at $ER = 0.32$, which yielded the average bed temperature at 810°C ($\pm 10^{\circ}\text{C}$). The product gas was sampled at 5 positions as shown in Figure 6, which result in the gas residence time from 2.5 s (at PS1) to 15.6 s (after the cyclone).

The gravimetric tar yields determined from different positions of sampling are plotted against the residence time in Figure 7. The tar concentration increased from 4.5 to 10.5 g/Nm^3 when increasing the residence time from 2.5 to 9.8 s. This suggests the formation of tar (probably both primary and secondary tar) due to a longer exposure at high temperature inside the gasifier. At the position after the cyclone, the tar concentration slightly decreased, probably due to the partial capture by cyclone.

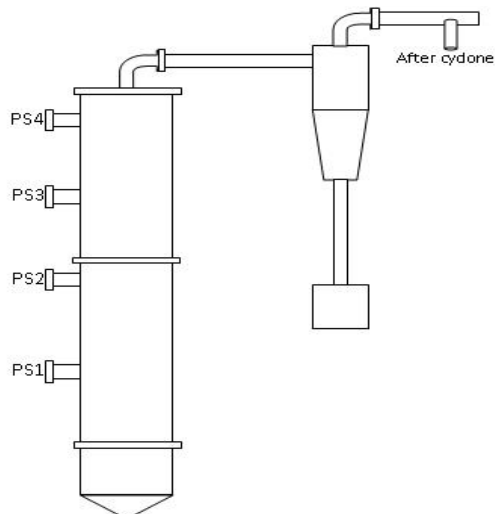

Figure 6. Positions of gas sampling port along the gasifier height and after cyclone.

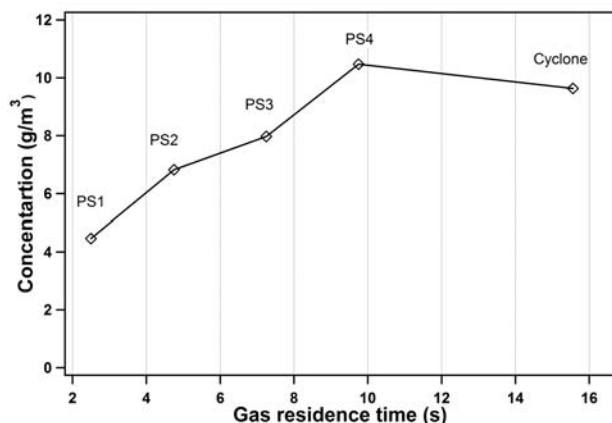

Figure 7. Tar concentrations from different sampling positions.

The occurrence of reactions of tar was investigated by further analyses of tar molecular weight distribution by gel permeation chromatography (GPC) as shown in Figure 8. Three resolved peaks centered at 100 - 150 amu, 240 - 280 amu and 350 - 380 amu could be observed for the four samples collected along the gasifier, while the middle peak disappeared for the sample collected after the cyclone. From the relative intensities, the first peak representing smaller molecular mass materials tends to increase as the residence time was extended, while the other two peaks representing larger molecular mass materials tend to decrease. The relative ratio between small to large molecular mass material generally increases, which is an indication of tar decomposition due to cracking, steam and dry reforming reactions to form smaller compounds. However, the increased ratio between the third and the second peak as the residence

time is extended to 9.8 s strongly suggests that the growth of aromatic ring (PAH) in the tar structure.

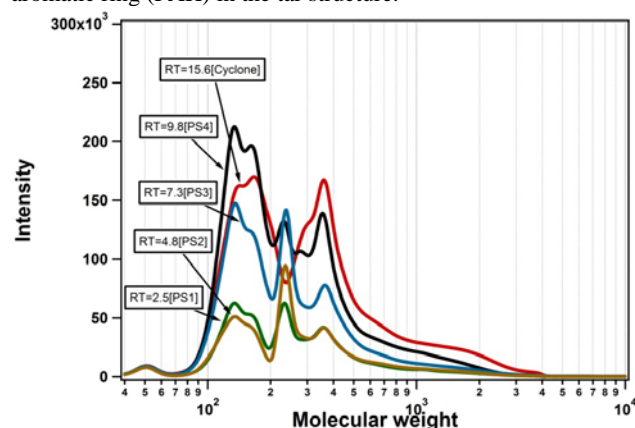

Figure 8. GPC chromatogram of the tar samples from different sampling positions.

The compositions of gas sampled at different positions with the corresponding gas residence times are illustrated in Figure 9. At all sampling positions, the main gas components were N_2 (not shown here), CO and CO_2 , with smaller but significant amounts of CH_4 , H_2 and light hydrocarbon gases (C_2H_n). The increased concentrations of CO and H_2 at longer residence time may be attributed to the tar reforming reactions and thermal cracking. H_2 is also a good indicator when converting the primary and/or secondary tar into PAH compounds [22]. C_2H_n initially increased but later decreased at extended residence time.

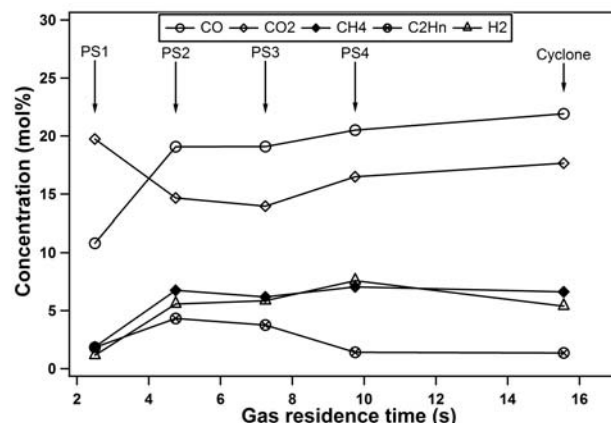

Figure 9. Compositions of gas from different sampling positions.

3. Summary discussion and the way forwards

The results have shown that, converting biomass into synthesis gas having the heating value of ~ 5 MJ/Nm^3 , the cold gasification efficiency was observed to be around 65%. The majority of the energy loss, or one-third of the input energy in biomass, was the loss through surrounding (mainly radiation) and sensible heat in the product gas. Utilizing the sensible heat is a viable option to increase the overall system efficiency, if not the gasification efficiency. Recovered sensible heat may be used to preheat the gasifying air or dry the biomass fuels prior to feeding into the gasifier.

The tar concentration in the product gas was found at ~ 10 g/m^3 , which is within a typical range for bubbling fluidized bed gasifier [23]. This level is far too high for the gas being used in internal combustion engines. Increasing ER evidently minimized tar concentration in the product gas; however, only partial reduction can be achieved. Moreover, the negative effect of ER on the product gas quality also needs to be considered.

Therefore, additional tar removal process which preferably converts tar into more useful gas products such as the use of catalytic bed materials or post-gasification catalytic tar reformer should be developed. Such catalysts must satisfy the following criteria: efficiency of tar elimination; mechanical strength (especially for bed materials); deactivation and coke deposition; cost. Many types of bed materials were used as alternative to silica sand, including dolomite [9,24], olivine [10-11], char [12-13], etc. Olivine seems to have high potential over dolomite for in-bed material due to its attrition resistance and containing iron oxides. Moreover, the removal of heavy tars by dolomite was difficult. The tar catalytic cracking effect by char is also worth further investigation. Post-gasification catalytic tar reforming may also be equipped in case that the tar concentration in the product is still above the level acceptable in gas engines/turbines. High surface area iron oxide catalyst is a promising option owing to its high resistance to coke formation as well as relatively low cost (in addition to its high tar cracking efficiency) [18], as compared to other high tar cracking efficiency catalysts such as nickel based catalysts [14-15].

Acknowledgements

The author would like to thank the National Metal and Materials Technology Center (MTEC) and the National Research University Project of Thailand's Office of the Higher Education Commission for the financial support. The preliminary fluidized bed experiments and tar analyses carried out by Kawee Wong Wongyara is highly appreciated.

References

- [1] Babu SP, IEA Bioenergy Agreement Task 33: Thermal gasification of biomass, Work Shop No. 1: Perspectives on Biomass Gasification (2006).
- [2] Krukanont P, Prasertsan S, Geographical distribution of biomass and potential sites of rubber wood fired power plants in Southern Thailand, *Biomass Bioenergy* 26 (2004) 47-59.
- [3] Kaewluan S, Pipatmanomai S, Potential of Synthesis Gas Production from Rubber Wood Chip Gasification in a Bubbling Fluidised Bed Gasifier, *Energy Conversion and Management* 52 (2011) 75-84.
- [4] Kaewluan S, *The study of factors affecting biomass gasification in bubbling fluidized bed reactors* (2010) PhD thesis, The Joint Graduate School of Energy and Environment, King Mongkut's University of Technology Thonburi, Thailand.
- [5] Hughes WEM, Larson ED, Effect of Fuel Moisture Content on Biomass-IGCC Performance, *Journal of Engineering for Gas Turbines and Power* 120 (1998) 455-459.
- [6] Cummer KR, Brown RC, Ancillary equipment for biomass gasification, *Biomass and Bioenergy* 23 (2002) 113-128.
- [7] Kaewluan S, Pipatmanomai S, Gasification of High Moisture Rubber Woodchip with Rubber Waste in a Bubbling Fluidized Bed. *Fuel Processing Technology* 92 (2011) 671-677.
- [8] Chobthiangtham P, Pipatmanomai S, Co-Gasification of Biomass and Plastic Waste in a Bubbling Fluidized Bed Gasifier, *Proceedings, World Renewable Energy Congress 2009 – Asia and The 3rd International Conference on "Sustainable Energy and Environment (SEE 2009)"*, 19-22 May 2009, Bangkok, Thailand
- [9] Gil J, Caballero MA, Biomass gasification with air in fluidized bed: effect of in-bed use of dolomite under different operation conditions, *Ind Eng Chem Res* 138 (1999) 4226-4235.
- [10] Devi L, Ptasinski KJ, Janssen FJJG, Van Paasen SVB, Catalytic decomposition of biomass tars: use of dolomite and untreated olivine, *Renewable Energy* 30 (2005) 565-587.
- [11] Devi L, Ptasinski KJ, Janssen FJJG, Pretreated olivine as tar removal catalyst for biomass gasifiers: investigation using naphthalene as model biomass tar, *Fuel Processing Technology* 86 (2005) 707-730.
- [12] El-Rub ZA, *Biomass char as in-situ catalyst for tar removal in gasification systems* (2008) PhD thesis, University of Twente, The Netherlands.
- [13] Neubauer Y, Behrendt F, Gasification of wood in a fluidized bed of char – influence of feed conditions on the tar content in the product gas, *Proceedings, 17th European biomass conference and exhibition* (2009) Hamburg, Germany
- [14] Simell P, Kurkela E, Stahlberg P, Hepola J, Catalytic hot gas cleaning of gasification gas, *Catal Today* 27 (1996) 55-62.
- [15] Zhang T, Amiridis MD, Hydrogen production via the direct cracking of methane over silica-supported nickel catalysts, *Appl Catal A: Gen* 167 (1998) 161-172.
- [16] Wang TJ, Chang J, Wu CZ, Fu Y, Chen Y, The steam reforming of naphthalene over a nickel-dolomite cracking catalyst, *Biomass Bioenergy* 28 (2005) 508-514.
- [17] Srinakruang J, Sato K, Vitidsant T, Fujimoto K, A highly efficient catalyst for tar gasification with steam, *Catal Commun* 6 (2005) 437-440.
- [18] Uddin A, Tsuda H, Wu S, Sasaoka E, Catalytic decomposition of biomass tars with iron oxide catalysts, *Fuel* 87 (2008) 451-459.
- [19] Brandt P, Henriksen U, Decomposition of tar in gas from updraft gasifier by thermal cracking, *Proceedings, The first world conference on biomass for energy and industry* (2000).
- [20] Paasen SVB, Tar formation in fluidized-bed gasification-impact of gasifier operating conditions, *Proceedings, The 2nd world conference and technology exhibition on biomass for energy, industry and climate protection* (2004).
- [21] Neef JPA, Knoef HAM, Zielke U, Sjoström K, Guideline for sampling and analysis of tar and particles in biomass producer gases (1998) European Commission.
- [22] Morf P, Hasler P, Nussbaumer T, Mechanisms and kinetics of homogeneous secondary reactions of tar from continuous pyrolysis of wood chips, *Fuel* 81 (2002) 843-853.
- [23] Han J, Kim H, The reduction and control technology of tar during biomass gasification/pyrolysis: An overview, *Renewable and Sustainable Energy Reviews* 12 (2008) 397-416.
- [24] RapagnVa S, Jand N, Foscolo PU, Catalytic gasification of biomass to produce hydrogen rich gas, *Int J Hydrogen Energ* 23 (1998) 551-557.