

## **Improving the Transient States Caused by Switching of Capacitor Banks in Power Dispatching Stations**

**Seyed Sajjad Salehi Ghaleh SEFID<sup>1,\*</sup>, Seyed Mohammad Hossein MOUSAVI<sup>2</sup> and Seyed Mohsen MIRBAGHERI<sup>3</sup>**

<sup>1</sup>*Regional Electricity Company of Khuzestan Province, the Northeast Region Exploitation Affairs, Mahshahr Branch, Mahshahr, Iran*

<sup>2</sup>*Sama Technical and Vocational Training College, Islamic Azad University, Mahshahr Branch, Mahshahr, Iran*

<sup>3</sup>*Department of Electrical Engineering, Masjed-Soleiman Branch, Islamic Azad University, Masjed- Soleiman, Iran*

(\* Corresponding author's e-mail: [s.salehi1983@gmail.com](mailto:s.salehi1983@gmail.com))

*Received: 14 April 2014, Revised: 1 September 2014, Accepted: 2 October 2014*

### **Abstract**

The high reactive power demand on the electrical power grid reduces the power factor and increases voltage drop. One of the compensation methods of required reactive power is the application of capacitor banks. Among the major problems with this equipment is shock, created at the moment of connection to the grid, which can cause accidents in power stations. While studying the statistical analysis of the incidents due to use of capacitor banks, this paper analyzes the shock caused by their connection, and realistically simulates a sample power station in the EMTP / WORKS software. Finally, this paper suggests useful and efficient methods to reduce the transient conditions caused by transient capacitor banks switching to the grid.

**Keywords:** Reactive power, capacitor banks, voltage drop, power stations, EMTP / WORKS software

### **Introduction**

In order to improve voltage profiles, and also to inject additional reactive power into the electrical power grid at times of peak load occurrence, we have to use reactive power sources. These sources improve the voltage drop, and also increase the power factor of the grid by injecting the amount of reactive power required by consumers. Synchronous condensers, static compensators and capacitors are examples of reactive power compensators, from which capacitors is the most economical and popular. These banks are extensively installed in small capacities in distribution grids and in higher capacities in electrical dispatching stations. Many investigations have been carried out on the application of capacitor banks in electricity networks. The results show that they are not always beneficial for the network, and they can create disturbances [1,2], or, at the time of connection, they can impose a severe shock to the network [3,4]. Most of the research carried out about this equipment has focused on this case. Therefore, some researchers have focused on analysis of switching of capacitor banks to better introduce the key factors of generated shock at the moment of connection [5,6] and even control the shock using certain methods [7,8]. Due to the high importance of capacitor bank usage, the research on this important equipment has not ended, so that even its lifetime was estimated to show the major causes of loss of life for the associated capacitive cells [9]. Studies carried out in the field of capacitor banks are mostly focused on distribution networks, and less attention has been devoted to the capacitor banks used in electrical power dispatching stations, which may be due to the greater expansion of distribution networks compared to power stations.

This paper first statistically analyzes the accidents caused by capacitor banks in power dispatching stations; then, for better understanding of these events, we will simulate one of the subsidiary dispatching stations of the regional power company of Khuzestan (South-West Iran), the capacitor banks of which had an accident in the EMTP/WORKS (Electro Magnetic Transients Program) software, one of the best software programs in the field of transient states. Finally, some methods are recommended for control and reduction of these incidents, which can be used to minimize the risks of using these facilities which have even resulted in damages to lives and properties.

### Statistical analysis of accidents caused by capacitor banks

Based on research carried out from 2006 to 2012 in South-West Iran in 147 subsidiary dispatching stations of the regional power company of Khuzestan (South-West Iran), the results of which can be seen in **Figure 1**, approximately 4.4 % of the accidents occurred in dispatching stations were caused by the capacitor banks.

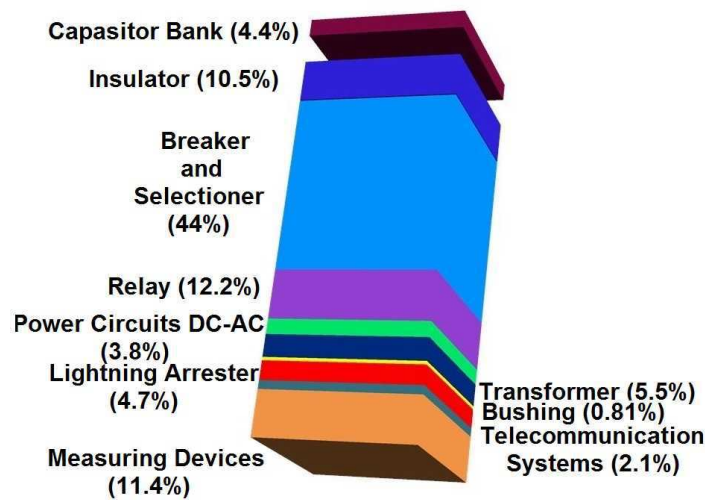

**Figure 1** Accidents caused by equipment of power stations.

For reasons specified in **Figure 2**, capacitor banks can cause some accidents. Unfortunately, the events in this equipment not only caused the loss of reactive power generation sources, but also eliminated other important equipment, such as transformers or transmission lines, from the circuit. In order to prevent such incidents in capacitor banks, more investigations need to be done. So, with the help of useful and modern techniques, such incidents can be prevented from occurring.

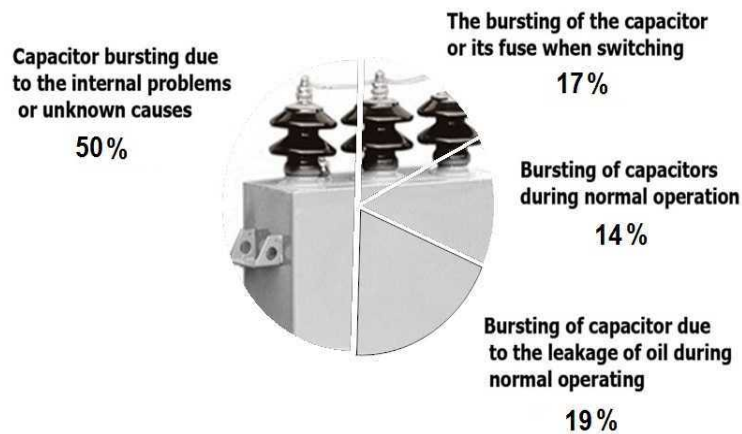

**Figure 2** Analysis of accidents caused by capacitor banks.

### Simulation of subsidiary power station of the regional electricity company of Khuzestan (South-West Iran)

In this section, a power dispatching station, belonging to one of the subsidiary companies of the regional electricity company of Khuzestan (South-West Iran) was simulated and analyzed using EMTP/WORKS software. The aforementioned power station is a 132/11 kV station, with 9 outgoing feeders, 3 power transformers, and 3 capacitor banks. Most of the accidents which occurred at the capacitor banks of this station were due to capacitor bank number 3, which is indicated by SC13 in the single-line drawings of the station. The image of the aforementioned capacitor bank is shown in **Figure 3**. This capacitor bank provides the reactive power of the feeders of power transformer no.3.



**Figure 3** Capacitor bank of a power station of the regional power dispatching company of Khuzestan (South-West Iran).

The SC13 capacitor is not stepped and, when closing its breaker, injects the entire reactive power capacity -which is about 4.8 MVAR- into the grid. In addition to causing damage to the cells of the capacitor bank, it causes the grid to experience severe shocks. **Figure 4** shows that some cells of the SC13 capacitor bank suffer from oil efflux, due to various reasons. Thus, based on **Figure 2**, this oil efflux has led to 19 percent of accidents being caused by this equipment in power plants.

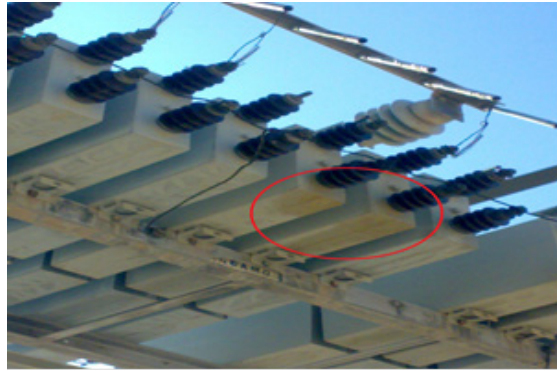

**Figure 4** Oil efflux from the cells of SC13 capacitor bank.

Simulation of the station using EMTP / WORKS software is shown in **Figure 5**. Due to the high volume of consumers, and the high length of its lines, all the feeders of power transformer no. 3 have been separately simulated in the mentioned software. Technical information associated with each cell of the SC13 capacitor bank and its breaker is presented in **Tables 1** and **2**.

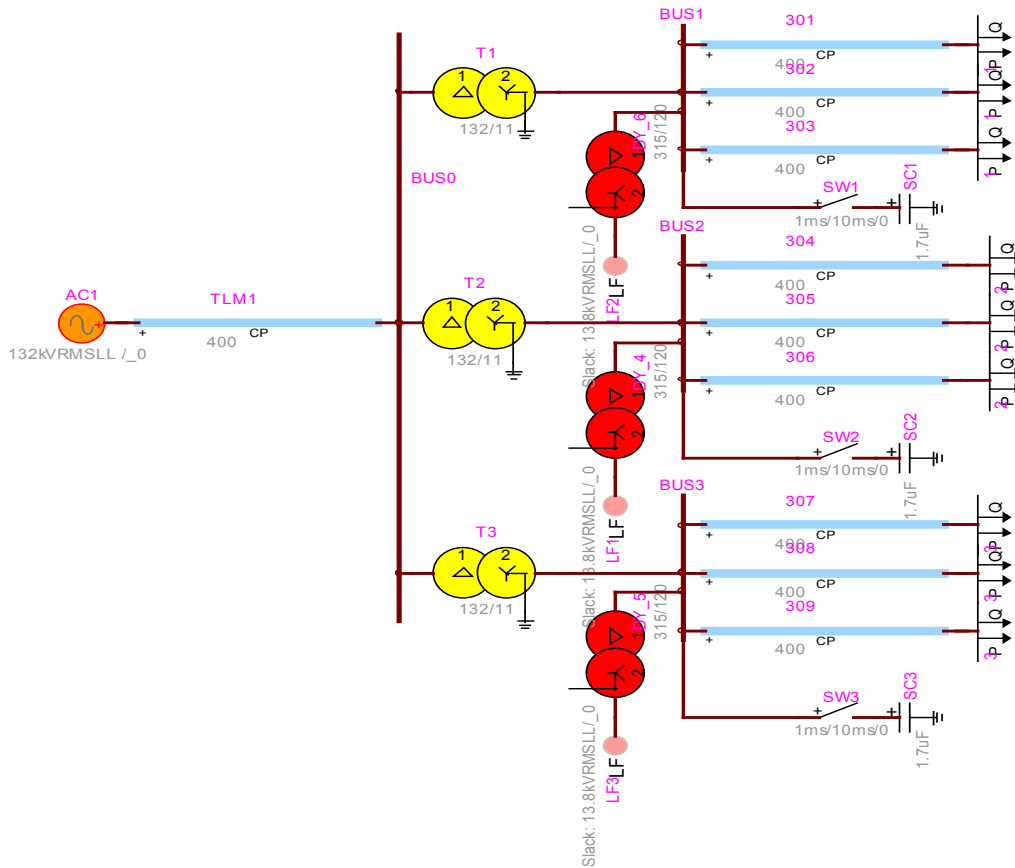

**Figure 5** Simulation of power dispatching station.

**Table 1** Technical specifications of the cells of capacitor bank.

Manufacturer's name	Sangamo
Capacity of each cell (KVAR)	200
Capacitance per cell ( $\mu\text{f}$ )	1.7
Nominal voltage of each cell (KV)	6.4
Number of cells in each phase	8

**Table 2** Technical specifications of breaker of the capacitor bank.

Manufacturer's name	McGraw-Edison Company
Maximum rated current (A)	400
Maximum nominal voltage (KV)	15.4

The simulation results of the mentioned power station using EMTP/WORKS software is shown in **Figures 6 - 9**. These results suggest the rate of shock of voltage and current created in the cell and breaker of the SC13 capacitor bank and the transformers connected to the output feeders at the moment of connection of the capacitor banks to the network. It is worth mentioning that, due to high volume of the existing equipments at the station, only the diagrams of some of the most important equipment are shown. Meanwhile, the time frame required for closing of the capacitor bank breaker has been considered as 18 milliseconds in the simulation.

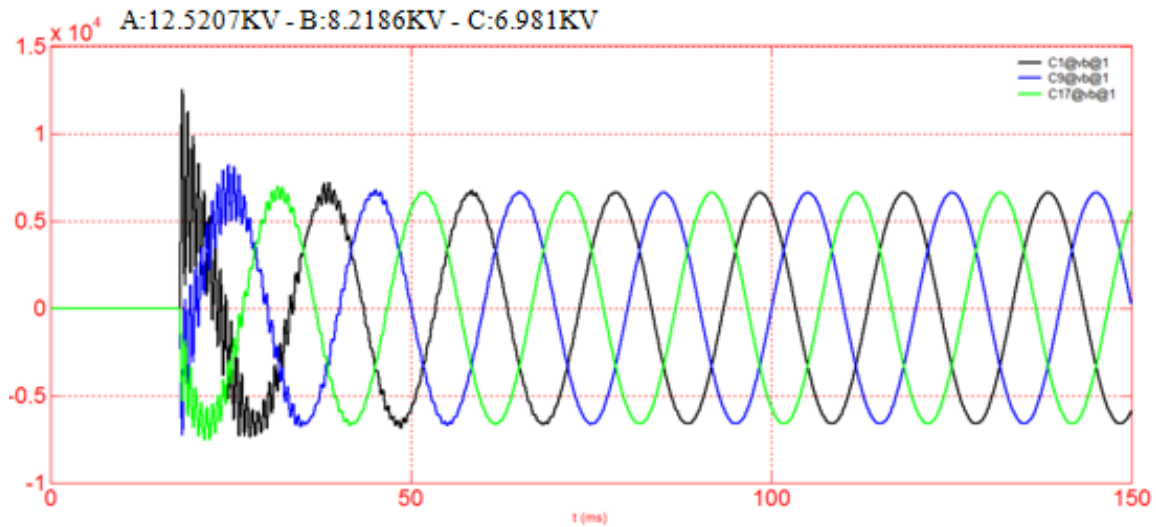

**Figure 6** Overvoltage generated in each cell.

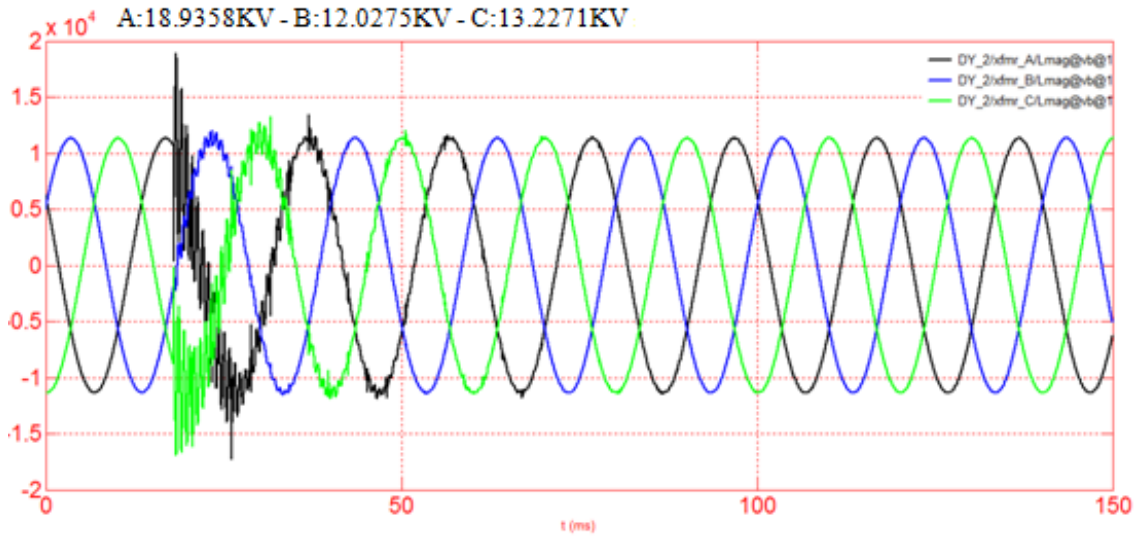

Figure 7 Overvoltage created in distribution transformers.

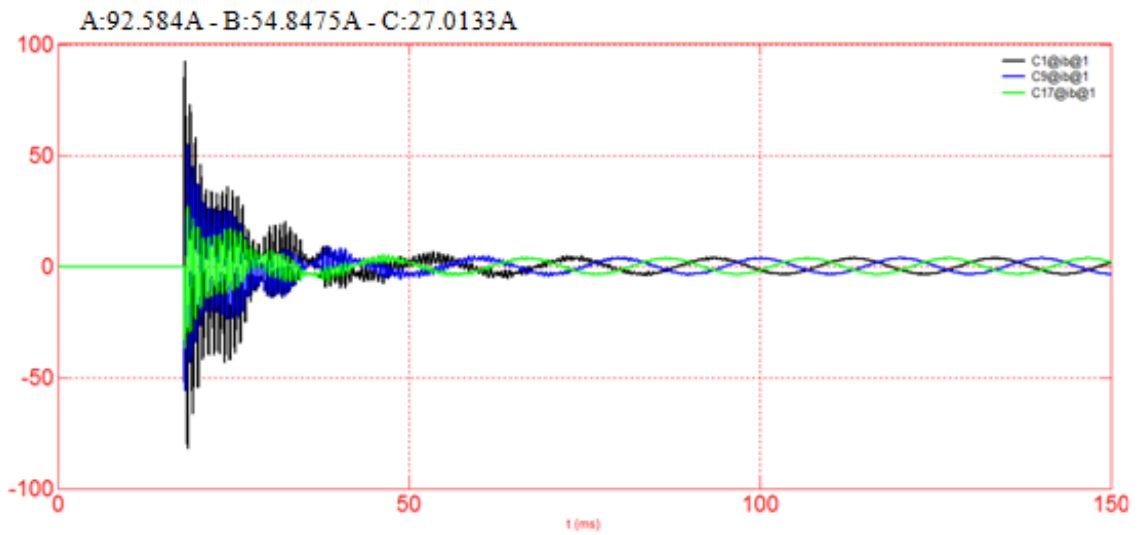

Figure 8 Overcurrent created in each cell.

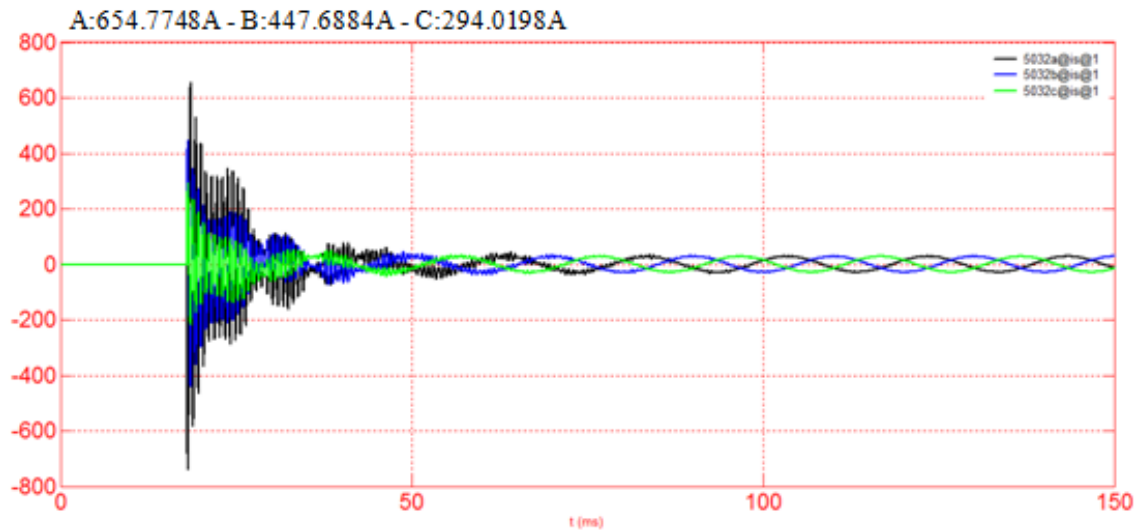

Figure 9 Overcurrent created in each capacitor bank breaker bridge.

Figures 6 and 7 show the amount of overvoltage generated on each capacitor cell and distribution transformer at the moment when the capacitor bank of the station is connected to the grid. Based on these figures, at the moment when the capacitor bank is connected to the grid, over 1.5 times the rated voltage of the mentioned equipments is applied to them. This amount of overvoltage can do serious damage to their insulation. This is also true for the overcurrent generated at the moment when the capacitor bank is connected. The same results can be concluded from Figures 8 and 9. The nominal current of each cell of the capacitor bank is about 31A; based on Table 2, for each breaker bridge, it is 400 A, while at moment of connection of the capacitor bank to the network, a current nearly 3 times the nominal current per cell, and more than 1.6 times the nominal current of each breaker bridge, will pass through them. This may result in premature wear of equipment over time.

#### Methods to reduce accidents caused by capacitor banks

Simulation results show that the main cause of accidents in capacitor banks is the shock created at the moment of their connection to the network. This shock can simultaneously lead to the bursting of cells and damage to them over time. This damage may appear as oil leakage, internal fault, burning of fuse links, loosening of fittings, etc. For a detailed investigation of this problem, the factors which specify the amount of overvoltage and overcurrent generated at the moment of the capacitor bank's connection to the grid must be determined. Therefore, methods of reducing these accidents should be investigated. It is worth mentioning that lack of annual maintenance of capacitor banks, such as repairs and electrical testing carried out by maintenance groups at regional electric companies, can also precipitate occurrence of these events.



**Analysis of overvoltage and overcurrent caused by switching of capacitor banks**

Figure 10 is a single line example related to a simulated power station.

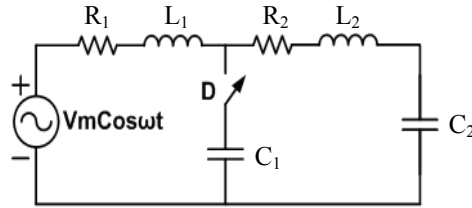

Figure 10 Single line example of simulated power station.

In Figure 10,  $R_1$  and  $L_1$  are respectively the impedance of transmission lines and power transformer no.3 between the SC13 capacitor bank shown by  $C_1$ , to the source.  $L_2$  and  $R_2$  are also the impedance of distribution transformers and lines from capacitor bank SC13 to capacitor  $C_2$ , installed on distribution lines by distribution companies. In this figure, capacitor bank breaker  $C_1$  is represented by D.

**Analysis of switching overvoltage of capacitor banks**

The voltage of the capacitor  $C_2$  is equal to Eq. (1) [10];

$$V_{C_2} = A_1 e^{-\delta_1 t} \cos B_1 t + A_2 e^{-\delta_2 t} \cos B_2 t + V_{m_2} \cos \omega t \tag{1}$$

As shown in Figure 10, it is clear that  $iC_2 = iL_2$ . Therefore, to calculate the capacitance current according to relation (2) we have;

$$iC_2 = iL_2 = C_2 \times V_{C_2}' = -A_1 B_1 C_2 e^{-\delta_1 t} \sin B_1 t - A_1 C_2 \delta_1 e^{-\delta_1 t} \cos B_1 t - A_2 C_2 B_2 e^{-\delta_2 t} \sin B_2 t - A_2 \delta_2 C_2 e^{-\delta_2 t} \cos B_2 t - \omega V_{m_2} C_2 \sin \omega t \tag{2}$$

Eq. (3) calculates the inductor voltage ( $L_2$ );

$$V_{L_2} = L_2 \times iL_2' = L_2 A_1 B_1 C_2 \delta_1 e^{-\delta_1 t} \sin B_1 t - A_1 C_2 B_1^2 L_2 e^{-\delta_1 t} \cos B_1 t + A_1 L_2 C_2 \delta_1^2 e^{-\delta_1 t} \cos B_1 t + A_1 B_1 L_2 C_2 \delta_1 e^{-\delta_1 t} \sin B_1 t + A_2 B_2 C_2 \delta_2 L_2 e^{-\delta_2 t} \sin B_2 t - A_1 C_2 B_2^2 L_2 e^{-\delta_2 t} \cos B_2 t + A_2 C_2 \delta_2^2 L_2 e^{-\delta_2 t} \cos B_2 t + A_2 B_2 C_2 \delta_2 L_2 e^{-\delta_2 t} \sin B_2 t - \omega^2 L_2 V_{m_2} C_2 \cos \omega t \tag{3}$$

As a result, we have;



$$\begin{aligned} V_{C_1} &= K_1 e^{-\delta_1 t} \cos B_1 t + K_2 e^{-\delta_2 t} \cos B_2 t \\ &+ K_3 e^{-\delta_1 t} \cos B_1 t + K_4 e^{-\delta_2 t} \cos B_2 t \\ &+ K_5 \cos \omega t \end{aligned} \quad (4)$$

in which;

$$\begin{aligned} K_1 &= A_1 L_2 C_2 \delta_1^2 - A_1 C_2 B_1^2 L_2 + A_1 \\ K_2 &= A_2 L_2 C_2 \delta_2^2 - A_2 C_2 B_2^2 L_2 + A_2 \\ K_3 &= 2 A_1 B_1 L_2 C_2 \delta_1 \\ K_4 &= 2 A_2 B_2 L_2 C_2 \delta_2 \\ K_5 &= (1 - \omega^2 L_2) V_{m2} \end{aligned}$$

From Eq. (4), we conclude that the voltage value of capacitor  $C_1$ , which represents the same overvoltage of the SC13 capacitor bank at the moment of switching, depends on the distribution capacitances of  $C_2$  and the capacity of the distribution transformers.

#### Analysis of switching overcurrent of capacitor banks

The current of capacitor  $C_1$  is given by Eq. (5);

$$\begin{aligned} i_{C_1} &= K_1' e^{-\delta_1 t} \cos B_1 t + K_2' e^{-\delta_2 t} \cos B_2 t \\ &+ K_3' e^{-\delta_1 t} \cos B_1 t + K_4' e^{-\delta_2 t} \cos B_2 t \\ &+ K_5' \sin \omega t \end{aligned} \quad (5)$$

In this equation;

$$\begin{aligned} K_1' &= K_3 B_1 C_1 - K_1 \delta_1 C_1 & K_3' &= -K_3 \delta_1 C_1 - K_1 B_1 C_1 \\ K_2' &= K_4 B_2 C_1 - K_2 \delta_2 C_1 & K_4' &= -K_4 \delta_2 C_1 - K_2 B_2 C_1 \\ K_5' &= -K_5 \omega C_1 \end{aligned}$$

Eq. (5) indicates that the current of capacitor bank SC13 at the moment of switching depends on the capacities of the capacitors.

According to the instructions of Iranian Ministry of Power, electrical power distribution companies are free to determine the capacity of transformers and capacitors installed in their distribution network, and the regional power companies responsible for the maintenance and operation of dispatching stations can only install capacitor banks in power plants, considering the required network capacity. Accordingly, by reducing the capacity of the installed capacitors and transformers in the distribution network, we cannot actually reduce the peak voltage shock of the capacitor banks in power plants, which is dependent on these two, and other methods should be used, which will be discussed in the following section.

### Proposed methods to reduce accidents caused by capacitor banks

#### Connection of capacitor banks to the network at the zero voltage moment

When a capacitor with no load is stimulated, the system voltage drops instantaneously (because the capacitor voltage cannot be changed instantaneously). Then, the system voltage jumps, and goes beyond the typical voltage level, and this voltage difference is equal to the voltage difference between the system voltage and capacitor voltage at the moment of stimulation of the capacitor. Therefore, the most severe transient state occurs when switching of a capacitor with no load occurs at voltage peak [11]. To mitigate this shock, the switch should be closed at the zero voltage time, to reduce the amount of shock imposed on equipment. In capacitor banks with a ground as their neutral (like the SC13 capacitor bank), 3 power switch bridges should be included, with a time difference of 1/6 cycles (3.3 ms in 50 Hz). In capacitor banks without a ground as their neutral, 2 phases of the switch should be simultaneously closed at zero phase to phase voltage, and the other bridge should be closed with a 1/4 cycle delay [12]. **Figures 11 to 14** represent the voltage and current diagram of each SG13 capacitor bank cell, and distribution transformers connected to output feeders at the time of the capacitor bank connecting in the zero voltage moment.

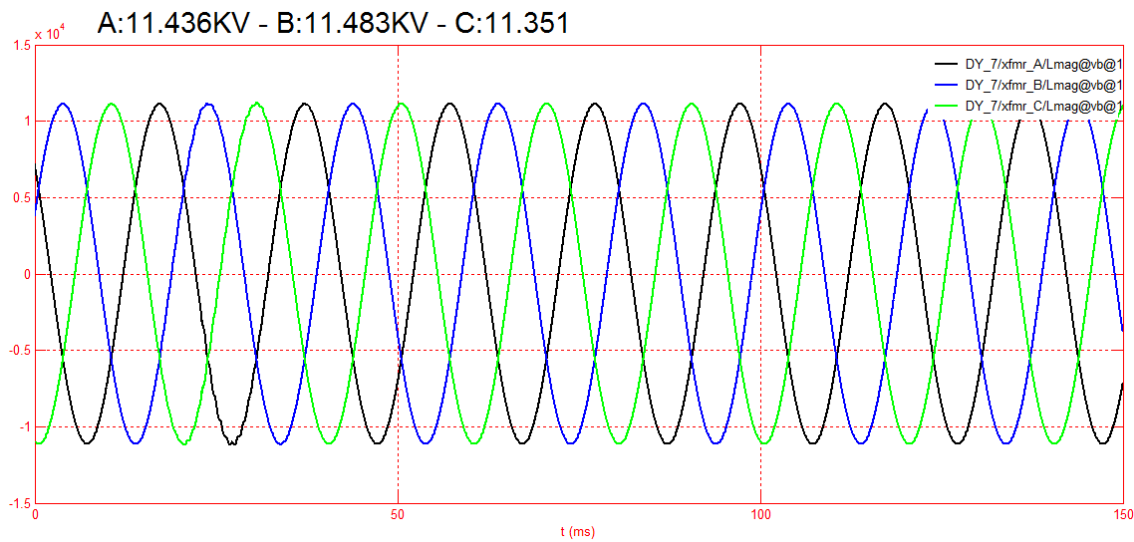

**Figure 11** Voltage diagram of distribution transformers (by using the first method).

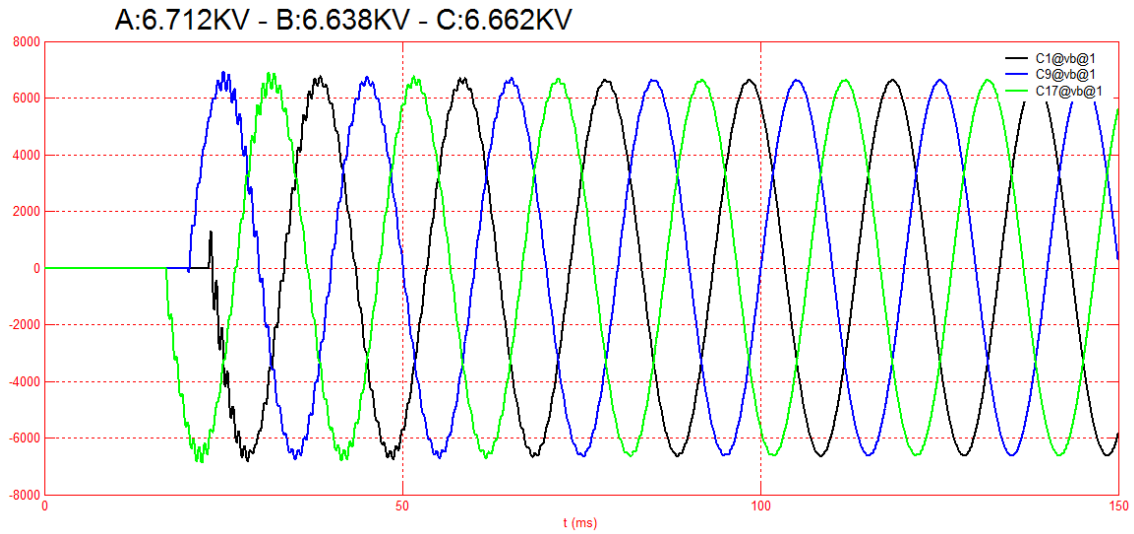

**Figure 12** Voltage diagram of capacitor bank cells (by using the first method).

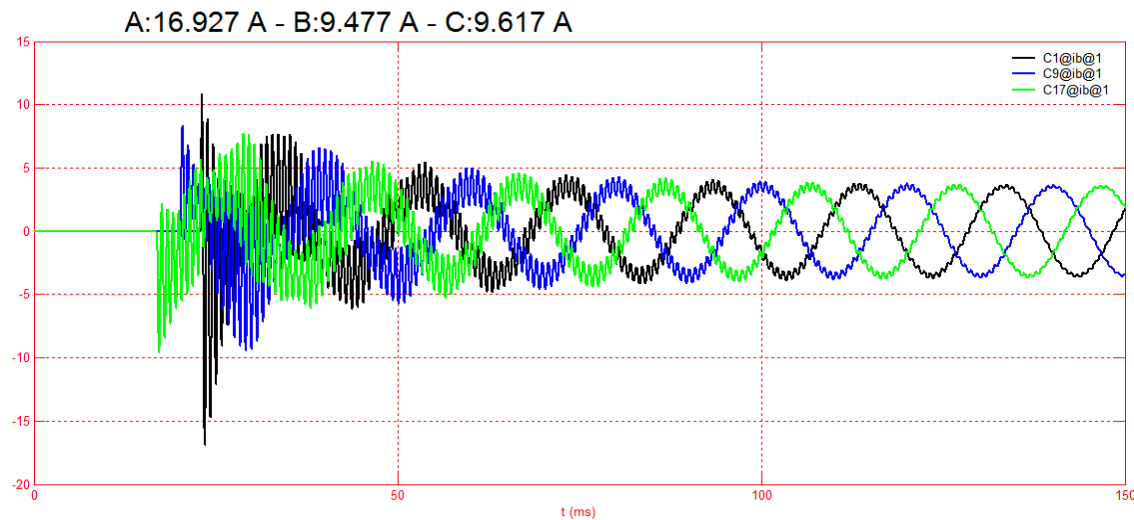

**Figure 13** Current diagram of capacitor bank cells (by using the first method).

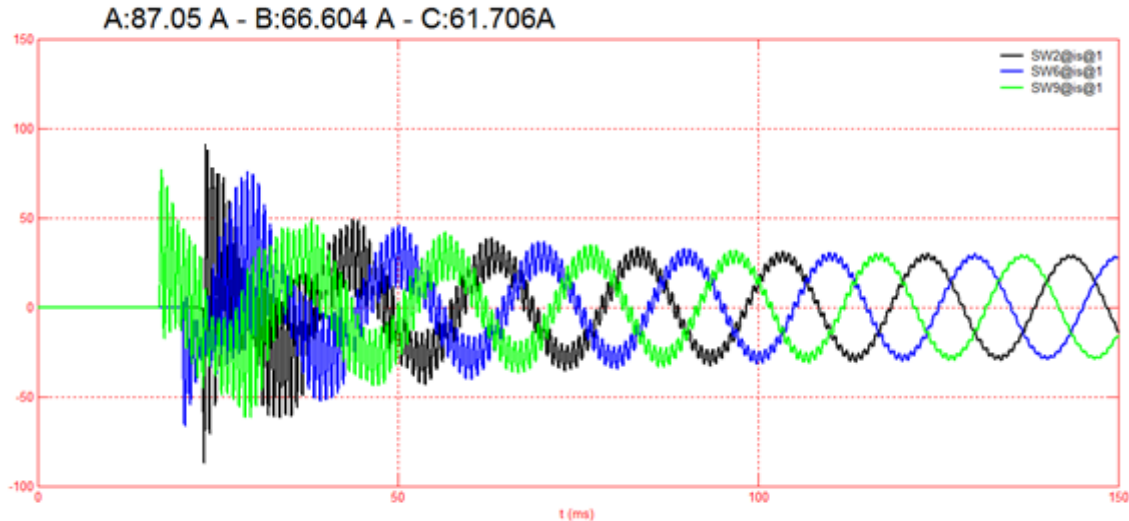

**Figure 14** Current diagram of every bridge of capacitor bank breaker (by using the first method).

#### Application of resistor in the structure of capacitor bank breaker

One of the more effective methods is application of a resistor in the structure of power switches. In this method, when closing the breaker, initially the resistor that has a value of 100 ohms per phase [13] enters the circuit by an auxiliary contactor, as in **Figure 15**; at this point, the main contactors of the breaker are connected, with an interval of a few milliseconds. By connecting these contactors, the resistor which reduces the voltage shock to the grid will become a short circuit; then, the auxiliary contactors will be separated, and eliminate the resistor from the circuit.

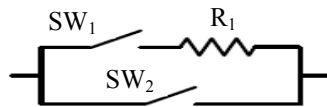

**Figure 15** Use of resistor in breaker structure.

**Figures 16** and **17** respectively represent reduced voltage shock, using a resistor in the structure of the power switch in the cell of the capacitor bank, and distribution transformers connected to the distribution feeders at the time of connection of the mentioned capacitor bank to the grid.

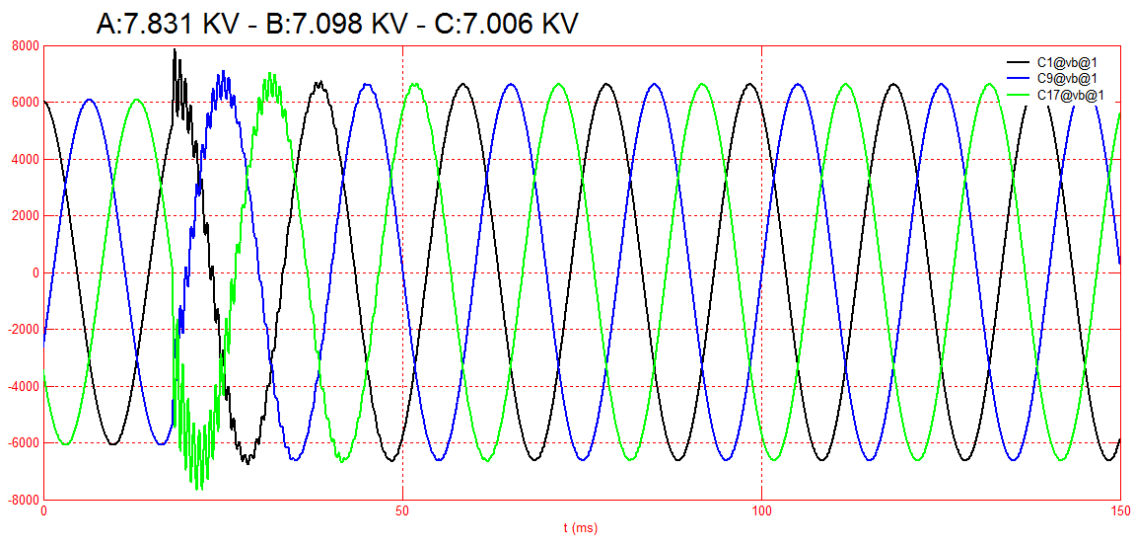

Figure 16 Voltage diagram of capacitor bank cells (by using the second method).

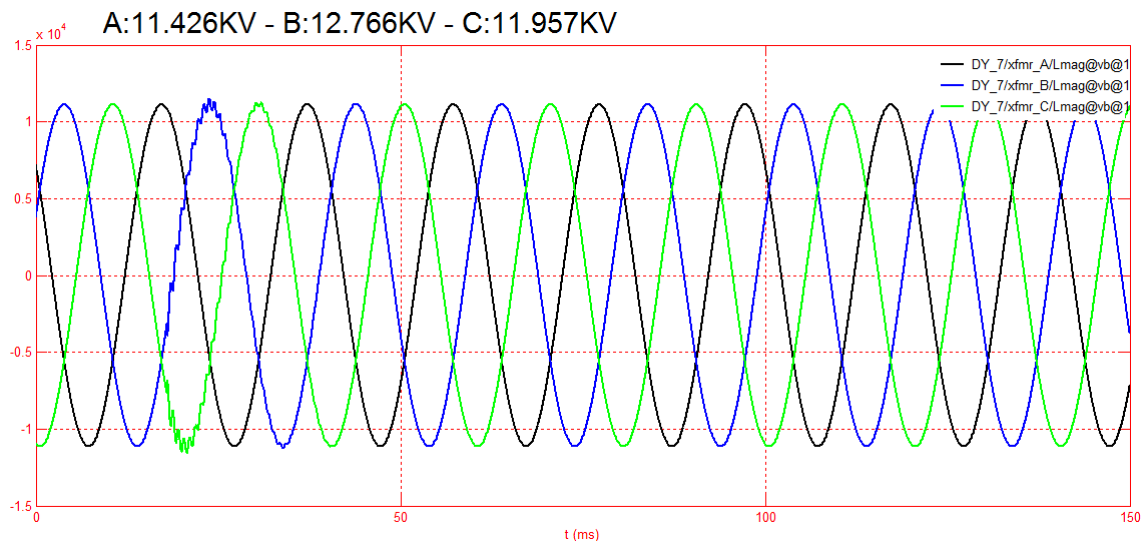

Figure 17 Voltage diagram of distribution transformers (by using the second method).

#### Using series reactors in capacitive banks

Using series reactors is one of the methods used to reduce the incoming current shock to the grid at the moment of connecting the capacitor bank breaker. When using high-capacity reactors, the peak current shock of connection time is reduced, but the plot spends more time to reach the damping. However, if we use low-capacity reactors, the peak current shock increases, but the diagram reaches the damping in a shorter time. **Figures 18 - 21** show the voltage plots of the SC13 capacitor bank cells at the moment of connecting the breaker of this bank to the grid. Meanwhile, we have used series reactors with different capacities in these diagrams.

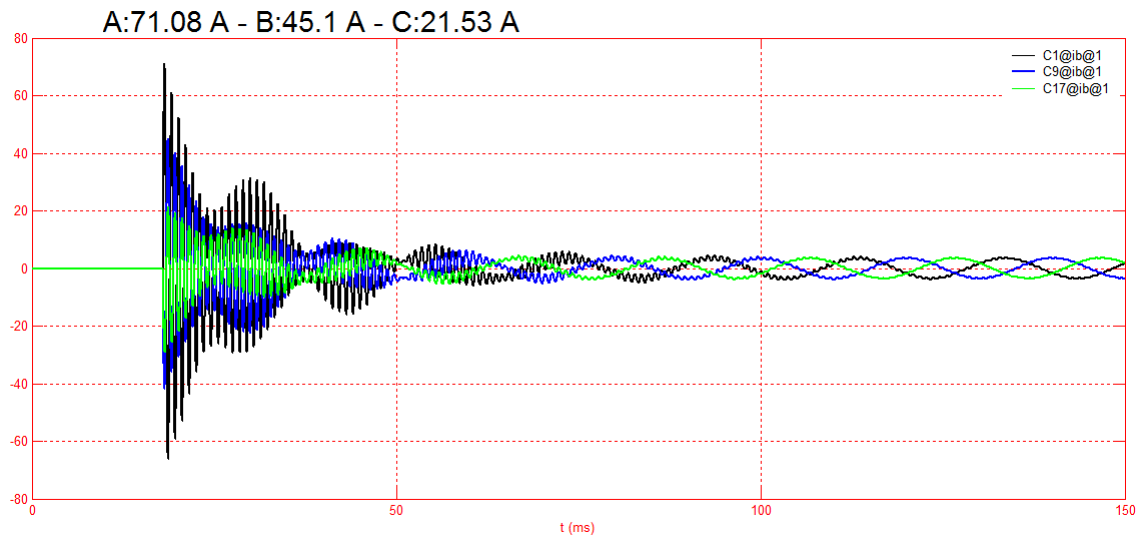

Figure 18 Current diagram of cells of capacitor bank with series reactor  $700 \mu H$ .

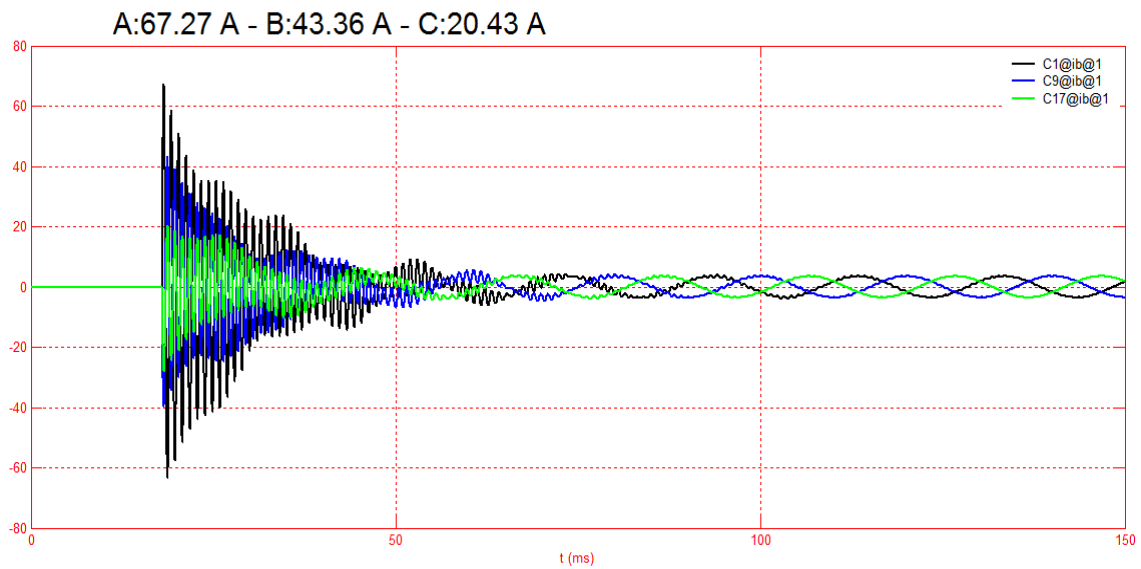

Figure 19 Current diagram of cells of capacitor bank with series reactor  $900 \mu H$ .

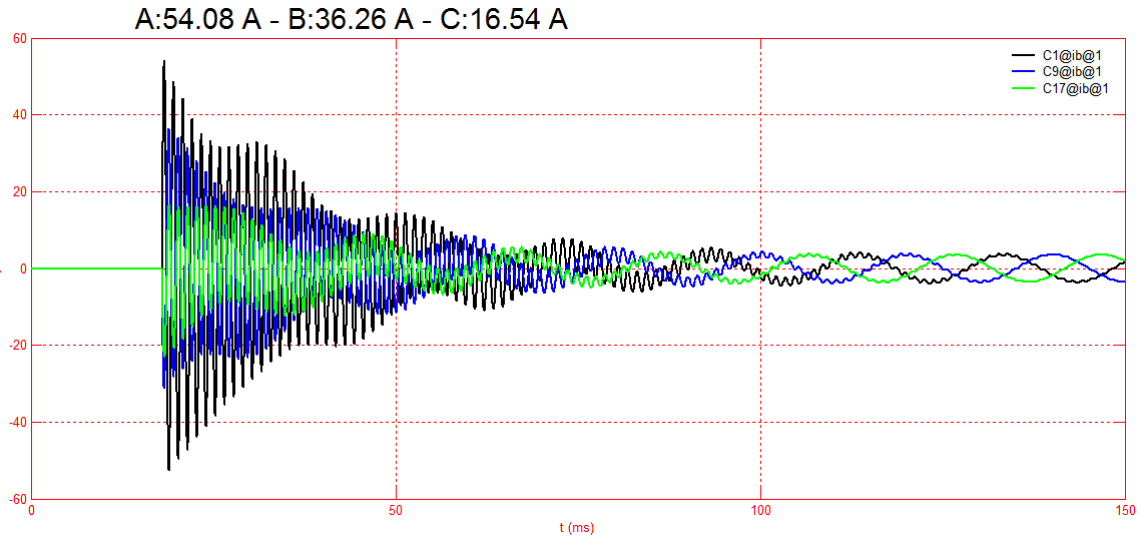

Figure 20 Current diagram of cells of capacitor bank with series reactor 2 mH.

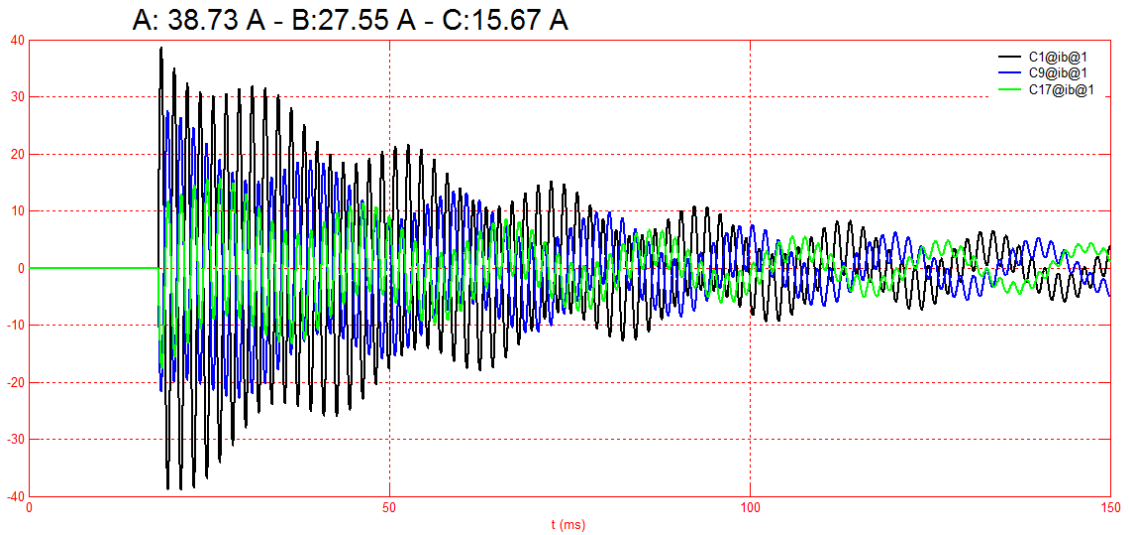

Figure 21 Current diagram of cells of capacitor bank with series reactor 5 mH.



### **Stepped connecting of capacitor banks to the grid**

The value of peak current shock at the time of connection of the capacitor banks to the grid depends on the capacity of the very cells of the capacitor bank. Stepping of the capacitor banks and of them entering into the grid, within some phases is one of the most useful methods for reducing the peak shock. In this method, if the power factor of the grid comes below the defined limit, the capacitors enter the circuit in a stepped manner, and within some phases, to both improve the grid power factor and weaken the shock resulting from the capacitor bank connection to the grid.

### **Using Arresters**

Arresters are devices used for grounding excessive voltage generated in the grid. These devices can be found in a large number in power stations, and are mounted around the transformers, on the buses and lines, etc. to inhibit excessive voltages, such as switching, lightning, grounding single phase short circuits, etc. By installing appropriate lightning arresters near capacitor banks, the overvoltage generated at the moment of its connection to the grid can be easily reduced.

### **Performing timely repairs**

Like other equipments in power stations, capacitor banks are in urgent need of annual maintenance. These repairs can involve tightening connections, fixing oil leakage, replacing fuses, replacing faulty bushings, or electrical tests. If these repairs are not performed on time, they may lead to more serious damages to the capacitive banks, and they will be eventually eliminated from the grid. These repairs are performed according to the diagnosis of regional power companies once or twice a year, and based on a request by a station operator if an emergency occurs.

### **Comparison of the proposed methods**

**Table 3** shows the amount of reduction of overvoltage and overcurrent generated on the facilities at the time of connection of capacitor bank to the grid, using different proposed methods.

### **Conclusions**

In accordance with the existing instructions of regional electric companies, due to possible explosion at the moment of network connection, capacitor banks are considered among the last options for eliminating the voltage drop, due to the high consumption of reactive power. In order to solve this problem for capacitor banks and optimize use of this important equipment in power plants, one can use the proposed methods, such as closing the breaker at the moment of zero voltage, application of resistors, reactors, and lightning arresters, and their stepped connections. Among the methods mentioned, it may be said that connecting the breaker at the zero time is more efficient compared to other methods. As can be seen in **Table 3**, the peak level of voltage and current shock in this technique is lower than other methods or has been largely eliminated. Unfortunately, the use of breakers equipped with connection and disconnection systems at the zero voltage time has still not become common in regional power companies. Application of this technique may not only prevent shock at the connection time of various states of capacitor banks to the grid, caused by equipment connection to the grid, but may also reduce the duration of outages for repairing the malfunction of this equipment, due to shocks generated at the time of their connection to the grid.

**Table 3** Percentage of overvoltage and overcurrent generated on the equipment.

	Type of equipment	Overcurrent (percent)	Overvoltage (percent)
<b>In normal conditions</b>	Capacitor cells	196	95
	Distribution transformer	-	72
	Capacitor bank breaker	63	-
<b>Connected at the zero voltage moment</b>	Capacitor cells	Lower than nominal current	4.8
	Distribution transformer	-	3.9
	Capacitor bank breaker	Lower than nominal current	-
<b>The use of resistor</b>	Capacitor cells	-	22
	Distribution transformer	-	3.8
<b>The use of reactor with the inductance of 700 <math>\mu</math>H</b>	Capacitor cells	129	-
<b>The use of reactor with the inductance of 900 <math>\mu</math>H</b>	Capacitor cells	115	-
<b>The use of reactor with the inductance of 2 H</b>	Capacitor cells	73	-
<b>The use of reactor with the inductance of 5 H</b>	Capacitor cells	23	-

**Acknowledgements**

The authors of this article appreciate the Khuzestan Regional Electricity Company for their cooperation in providing the required information.

**References**

[1] PKS Lim, TK Wyatt, CW Wooddell and CW Bray. Power quality considerations for installing sensitive electronics equipment-a utility's perspective. *In: Proceeding of the Conference on Power Electronics and Drive Systems, Singapore, 1997*, p. 850-6.

[2] CJ Kim and BD Russell. Classification of faults and switching events by inductive reasoning and expert system methodology. *IEEE Trans. Power Deliv.* 1989; **4**, 1631-7.

[3] PL Mao and RK Aggarwal. A novel approach to the classification of the transient phenomena in power transformers using combined wavelet transform and neural network. *IEEE Trans. Power Deliv.* 2001; **16**, 654-60.

[4] SJ Kulas. Capacitor Switching Techniques. *In: Proceeding of the Conference on Renewable Energies and Power, Valencia, Spain, 2009*.

[5] DB Mupperty. 2011, Capacitor Switching Transient Modeling and Analysis on an Electrical Utility Distribution System Using Simulink Software. Master's Thesis, University of Kentucky, UK.

[6] A Kalyuzhny. Switching Capacitor Bank Back-to-Back to Underground Cables. *IEEE Trans. Power Deliv.* 2013; **28**, 1128-37.

[7] JR Santos, AG Exposito and JLM Ramos. A reduced-size genetic algorithm for optimal capacitor placement on distribution feeders. *In: Proceeding of the 12<sup>th</sup> IEEE Mediterranean Electrotechnical Conference, Dubrovnik, Croatia, 2004*, p. 963-6.

- [8] A Bidram, M Hamedani-Golshan and A Davoudi. Capacitor design considering first swing stability of distributed generation. *IEEE Trans. Power Syst.* 2012; **27**, 1941-8.
- [9] C Guillermin, O Dujeu and JM Lupin. Metallized film power capacitors end-of-life study through monitored destruction tests. *IEEE Trans. Power Deliv.* 2013; **28**, 368-75.
- [10] A Kalyuzhny, S Zissu and D Shein. Analytical study of voltage magnification transients due to capacitor switching. *IEEE Trans. Power Deliv.* 2009; **24**, 797-805.
- [11] TA Short. *Electric Power Distribution Handbook*. CRC Press, New York, 2003, p. 543-51.
- [12] RW Alexander. Synchronous closing control for shunt capacitors. *IEEE Trans. Power Apparatus Syst.* 1985; **104**, 2619-26.
- [13] TE Grebe and EW Gunther. Application of the EMTP for analysis of utility capacitor switching mitigation techniques. *In: Proceeding of the 8<sup>th</sup> International Conference on Harmonics and Quality of Power*, Athens, Greece, 1998, p. 583-9.